



**FUEL CLOUD**



**CloudBox V1.4**

**Installation Manual**

Hardware Version 1.4

Manual Version 1.1

Revised 1/13/25



# Welcome to FuelCloud!

This installation guide contains all of the information you need to install your hardware, create your online account, and begin using FuelCloud.

**Before beginning physical installation of your FuelCloud hardware, create an account at [fuelcloud.com](https://fuelcloud.com)** and register your device's serial number to your account. Physical installation cannot be completed without an online account.

For help on the FuelCloud website, please see the Quick Setup Guide video on the dashboard.



**Get the installer app today!**



# Table of Contents

Privacy Statement / FCC Statement / Terms and Conditions	3
Compatibility & Specs	3
<hr/>	
<b>Before Installation</b>	
Hardware and Install Warnings	6
Additional Warnings	9
Certifications / Approvals	9
Check List	10
Identify Your Installation Location	11
Turn Power Off	12
Mount	12
<hr/>	
<b>Installation</b>	
Standalone Pump Wiring	13
DC Site Wiring	13
120V AC Pump Wiring	14
240V AC Pump Wiring	15
DC Pump Wiring	16
Dispenser Control	17
Pulsers	18
Pulser Wiring	19
Local Network Option	20
Power On & Verification	21
CloudBox Overview	23



## Privacy Statement

FuelCloud is committed to protecting user's privacy. For more information about FuelCloud's privacy policy, please review our full terms and conditions at: [fuelcloud.com/legal/privacy-policy](https://fuelcloud.com/legal/privacy-policy)



## FCC Statements

Find complete details of our FCC compliance at: [fuelcloud.com/legal/fcc-compliance](https://fuelcloud.com/legal/fcc-compliance)



## Terms and Conditions

For complete terms and conditions, including warranty disclaimers visit: [fuelcloud.com/legal/terms-condition](https://fuelcloud.com/legal/terms-condition)



## Compatibility & Specs

### Radio Specifications:

Technology	Frequency Band	Maximum Power
WLAN 802.11BG	2400-2484 MHz	+18 dBm
Bluetooth	2.4Ghz	+8 dBm

## Hardware Specifications:

<b>Input Power Requirements</b>	100-240VAC, 50/60Hz, 60W 8-50VDC*, 24W *DC requires a Class 2 power source
<b>Pump Control Ratings</b>	1HP, 125VAC 2HP, 240VAC 125VAC, 16A General Purpose, 2000W 240VAC, 15A General Purpose, 3600W 8-50VDC, 20FLA/60LRA, 1000W 8-50VDC, 30A General Purpose, 1500W
<b>Dimensions</b>	<b>Height:</b> 11.02" (279.91mm) <b>Width:</b> 7.48" (189.99mm) <b>Depth:</b> 5.51" (139.95mm)
<b>Weather Ratings</b>	NEMA 4X / IP67
<b>Temperature Ratings</b>	-4°F to 122°F (-20°C to 50°C)
<b>Pulser</b>	<b>Power supply:</b> 12VDC, 100mA <b>Rate:</b> 1:1 to 10,000:1 <b>Speed:</b> 120,000 pulses per minute <b>Duty cycle:</b> 50% <b>Contact:</b> (ex: reed switch, contact close) <b>Open collector:</b> (ex: 12VDC, signal, ground)
<b>I/O</b>	RS485 RS232 Ethernet 5V USB power

## Declaration of Conformity:

Hereby, FuelCloud, declares that this CloudBox is in compliance with the essential requirements and other relevant provisions of Directive 2014/53/EU. The full text of the EU declaration of conformity is available at the following internet address: [URL of DoC]

FuelCloud vakuuttaa täten että CloudBox tyyppinen laite on direktiivin 2014/53/EU oleellisten vaatimusten ja sitä koskevien direktiivin muiden ehtojen mukainen. The full text of the EU declaration of conformity is available at the following internet address: [URL of DoC]

Hierbij verklaart FuelCloud dat het toestel CloudBox in overeenstemming is met de essentiële eisen en de andere relevante bepalingen van richtlijn 2014/53/EU. The full text of the EU declaration of conformity is available at the following internet address: [URL of DoC]

Bij deze verklaart FuelCloud dat deze CloudBox voldoet aan de essentiële eisen en aan de overige relevante bepalingen van Richtlijn 2014/53/EU. The full text of the EU declaration of conformity is available at the following internet address: [URL of DoC]

Par la présente FuelCloud déclare que l'appareil CloudBox est conforme aux exigences essentielles et aux autres dispositions pertinentes de la directive 2014/53/EU. The full text of the EU declaration of conformity is available at the following internet address: [URL of DoC]

Par la présente, FuelCloud déclare que ce CloudBox est conforme aux exigences essentielles et aux autres dispositions de la directive 2014/53/EU qui lui sont applicables. The full text of the EU declaration of conformity is available at the following internet address: [URL of DoC]

Hiermit erklärt FuelCloud, dass sich dieser/diese/dieses CloudBox in Übereinstimmung mit den grundlegenden Anforderungen und den anderen relevanten Vorschriften der Richtlinie 2014/53/EU befindet". (BMW) The full text of the EU declaration of conformity is available at the following internet address: [URL of DoC]

ΜΕ ΤΗΝ ΠΑΡΟΥΣΑ FuelCloud ΔΗΛΩΝΕΙ ΟΤΙ CloudBox ΣΥΜΜΟΡΦΩΝΕΤΑΙ ΠΡΟΣ ΤΙΣ ΟΥΣΙΩΔΕΙΣ ΑΠΑΙΤΗΣΕΙΣ ΚΑΙ ΤΙΣ ΛΟΙΠΕΣ ΣΧΕΤΙΚΕΣ ΔΙΑΤΑΞΕΙΣ ΤΗΣ ΟΔΗΓΙΑΣ 2014/53/EU. The full text of the EU declaration of conformity is available at the following internet address: [URL of DoC]

Con la presente FuelCloud dichiara che questo CloudBox è conforme ai requisiti essenziali ed alle altre disposizioni pertinenti stabilite dalla direttiva 2014/53/EU. The full text of the EU declaration of conformity is available at the following internet address: [URL of DoC]

Por medio de la presente FuelCloud declara que el CloudBox cumple con los requisitos esenciales y cualesquiera otras disposiciones aplicables o exigibles de la Directiva 2014/53/EU. The full text of the EU declaration of conformity is available at the following internet address: [URL of DoC]

FuelCloud declara que este CloudBox está conforme com os requisitos essenciais e outras disposições da Directiva 2014/53/EU. The full text of the EU declaration of conformity is available at the following internet address: [URL of DoC]



BEFORE INSTALLATION

## Hardware and Install Warnings

Installations must be in accordance with the National Electrical Code (NFPA No. 70) and the Automotive and Marine Service Station Code (NFPA No. 30A). The installer is responsible for investigating and following any applicable local codes.

### Restricted Access:

Access can only be gained by service persons or by users who have been instructed about the reasons for the restrictions applied to the location and about any precautions that shall be taken.

Access is through the use of a tool or lock and key, or other means of security, and is controlled by the authority responsible for the location.

Seal offs must be used when conduit is exiting an explosion proof zone. (class 1 div 1 or class 1 div 2)

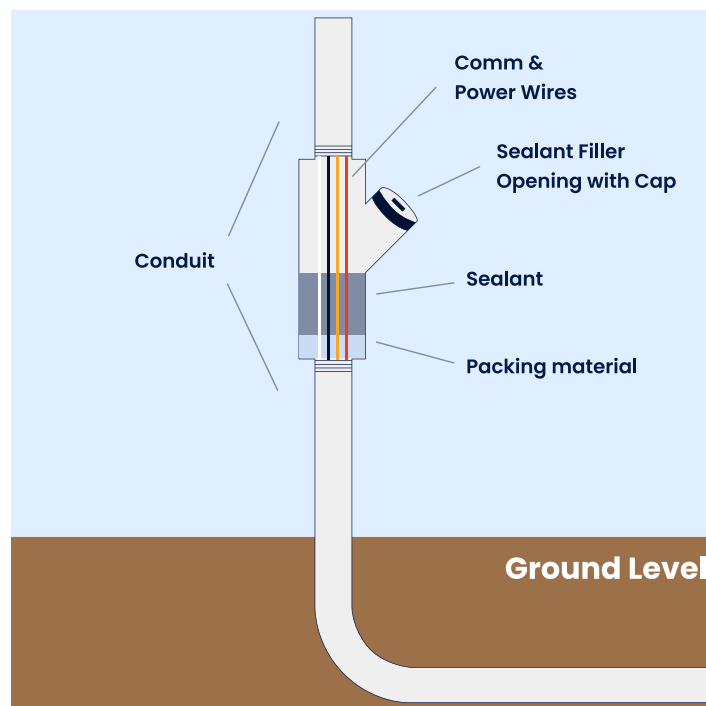

**Hazardous Area** (Where not to mount the CloudBox):

Do not mount the CloudBox or any FuelCloud device within the hazardous / classified area.

**Hazardous Zones:**

Dispensing Device	Class 1 Div 1	Class 1 Div 2
Compressed natural gas (CNG)	Entire space within the dispenser enclosure.	1.5 m (5 ft) in all directions from the dispenser enclosure.
Liquefied natural gas (LGN)	Entire space within the dispenser enclosure.	3 m (10 ft) in all directions from the dispenser enclosure.
Liquefied petroleum gas (LP-Gas)	Entire space within the dispenser enclosure; 450 mm (18 in.) from the exterior surface of the dispenser enclosure to an elevation of 1.22 m (4 ft) above the base of the dispenser; the entire pit or open space beneath the dispenser and within 6 m (20 ft) horizontally from any edge of the dispenser when the pit or trench is not mechanically ventilated.	Up to 450 mm (18 in.) above ground and within 6 m (20 ft) horizontally from any edge of the dispenser enclosure, including pits or trenches within this area when provided with adequate mechanical ventilation.

\*Pulled from NEC 2018



# Hazardous Area Examples:

Classified areas adjacent to dispenser mounted on aboveground storage tank:

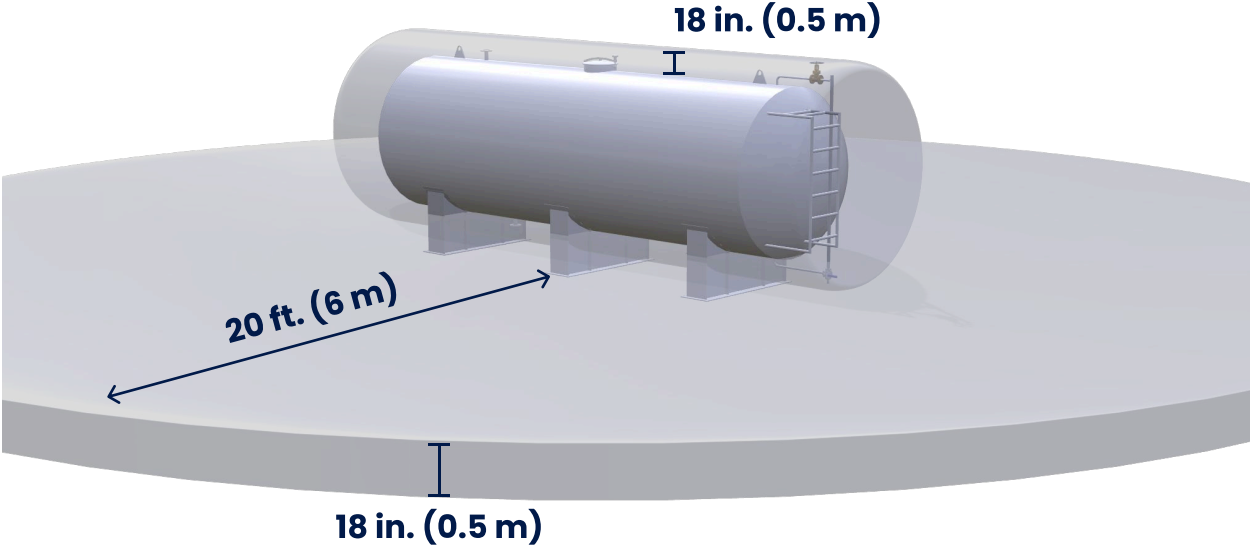

Classified areas adjacent to dispensers:

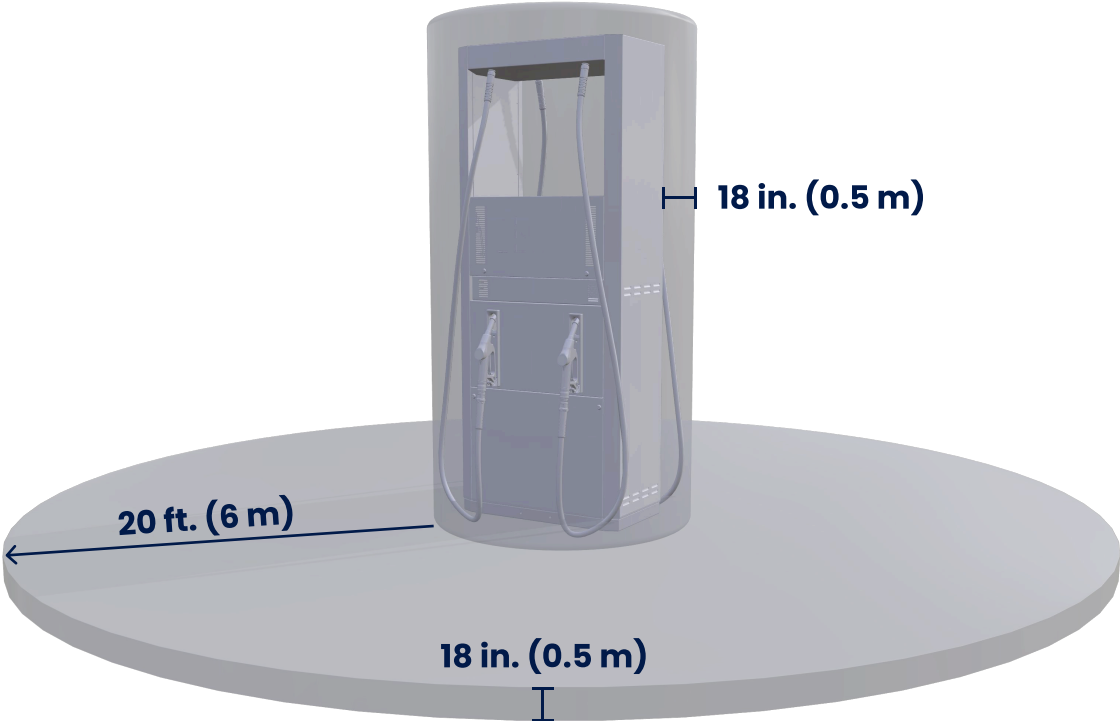

## Wireless Warnings

The total wireless range of the CloudBox is 75' of line of site. To ensure best performance, do not install the CloudBox in a location where the signal can be blocked or degraded.

## Additional Warnings

**Battery Replacement:** The CloudBox contains a rechargeable battery. If the battery needs to be replaced, please contact FuelCloud or an authorized technician.

**External Devices:** All peripheral equipment connected to the CloudBox system must be UL and CSA listed.

## Certifications / Approvals

The CloudBox is UL/cUL 1238 listed: MH61718

<b>FuelCloud OPCO, LLC</b>	<b>FuelCloud FCHCB0001.4UL</b>	
RATINGS:		
Max Ambient Temperature Rating: 50°C		
Input:	100-240VAC, 50/60 Hz, 3600W 8-50VDC, 1500W	
Output:	100-240VAC, 50/60 Hz 125VAC 1HP 240VAC 2HP 125VAC 16A General Purpose	240VAC 15A General Purpose 8-50VDC 30A General Purpose 8-50VDC, FLA 20A LRA 60A
Enclosure:	NEMA 4X	
For supply connection use wires rated for at least 90C (194F). For use with equipment specified in the installation instructions.		
<b>SEE INSTALLATION INSTRUCTIONS</b>		
WARNING SIGNAL WIRING IN THIS BOX MUST BE RATED AT LEAST 300V.		
CAUTION: BONDING BETWEEN CONDUIT CONNECTIONS IS NOT AUTOMATIC AND MUST BE PROVIDED AS A PART OF THE INSTALLATION.		
ATTENTION: LE CABLAGE DE SIGNALISATION RACCORD POUR UNE TENSION NOMINALE D'AU MOINS 300V.	É DANS CETTE DOÏTE DOIT CONVENIR	
ATTENTION: L'INTERCONNEXION DES CONDUITS NE SUFFIT PAS POUR ASSURER LA MISE MASSE; ELE DOIT FAIRE PARTIE INT ÉGRANTE DE L'INSTALLATION.	À LA	
This device complies with Part 15 of the FCC Rules. Operation is subject to the following two conditions: (1) this device may not cause harmful interference, and (2) this device must accept any interference received, including interference that may cause undesired operation.		





BEFORE INSTALLATION

## Check List

Complete the following steps before beginning installation of FuelCloud hardware. Failure to perform the below checks may result in the FuelCloud system or fuel equipment being damaged or not working as intended.

- 1** Turn off all power to the pump and tank.
- 2** Ensure that your installation location meets the following physical requirements:
  - ✓ Clear line of site to pump **or** located where wireless signal will not be blocked or degraded.
  - ✓ No wiring obstructions.
  - ✓ Good cellular connectivity.
  - ✓ Hardware will be mounted outside of hazardous zones – see **warnings** for more information.
  - ✓ Hardware dimensions for mounting: 11.02"H x 7.48"W x 5.51"D (279.91mm H x 189.99mm W x 139.95mm D).
- 3** Ensure that your site power supply and fuel equipment is compatible with FuelCloud's hardware. See **Compatibility & Specs** for more information.



BEFORE INSTALLATION

# Identify Your Installation Location

Ensure the following:

- Line of sight to the CloudBox
- Good LTE cellular coverage
- Fueling within 75' of the CloudBox





BEFORE INSTALLATION

## Turn Power Off

Turn off all power to the pump at the breaker.



BEFORE INSTALLATION

## Mount

Attach the 4 included Mounting Brackets and screws to the CloudBox. Use any available fasteners to mount the CloudBox.

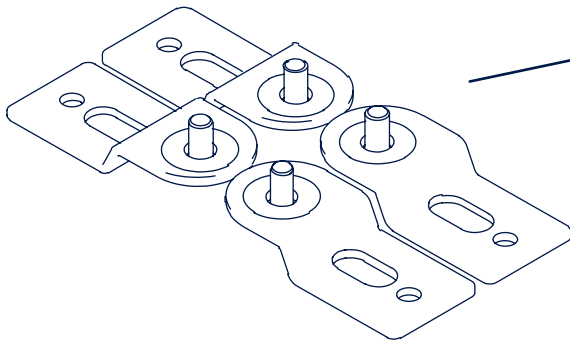

Included with  
CloudBox (4x)

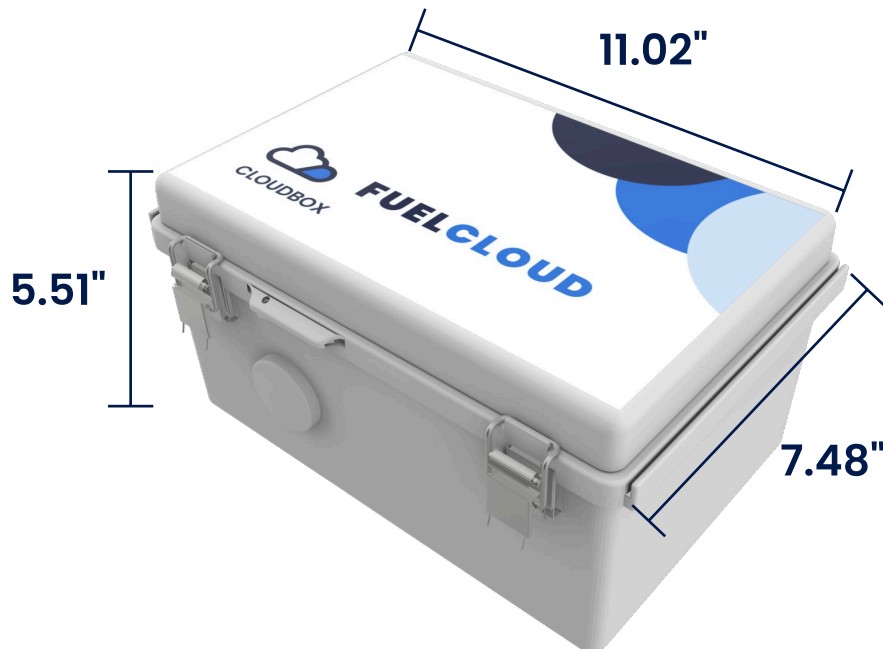



INSTALLATION

## Standalone Pump Wiring

### FuelCloud Hardware Power In / Power Out

The CloudBox can work on AC or DC power.



**Warning:** The CloudBox requires an external circuit-breaker (AC) or fuse (DC) be connected before the input power. It is recommended that the current protection devices are located near the CloudBox.

**Wiring Requirements:** All connections to the terminal board must be made using conductors rated 300V minimum.

- **Tightening:** Min 0.5 Nm, Max 0.6 Nm
- **Type:** Copper solid or stranded
- **Wiring gauge:** 10-30AWG



INSTALLATION

## DC Site Wiring

For mobile site applications, the CloudBox switches the pump, PTO, or solenoid on ground. This means that the pump, PTO, or solenoid's **DC- cannot be grounded to the truck chassis.**

A solenoid valve should be used with a PTO, otherwise fuel can be turned on or off without control from the FuelCloud app.

# 120VAC Pump Wiring

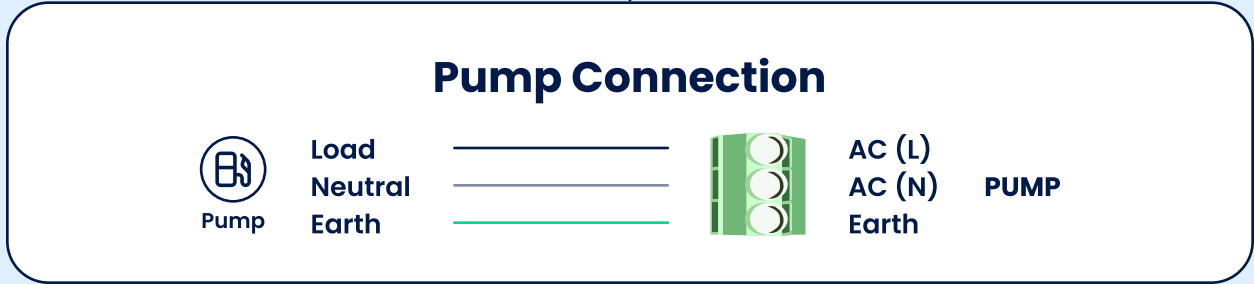
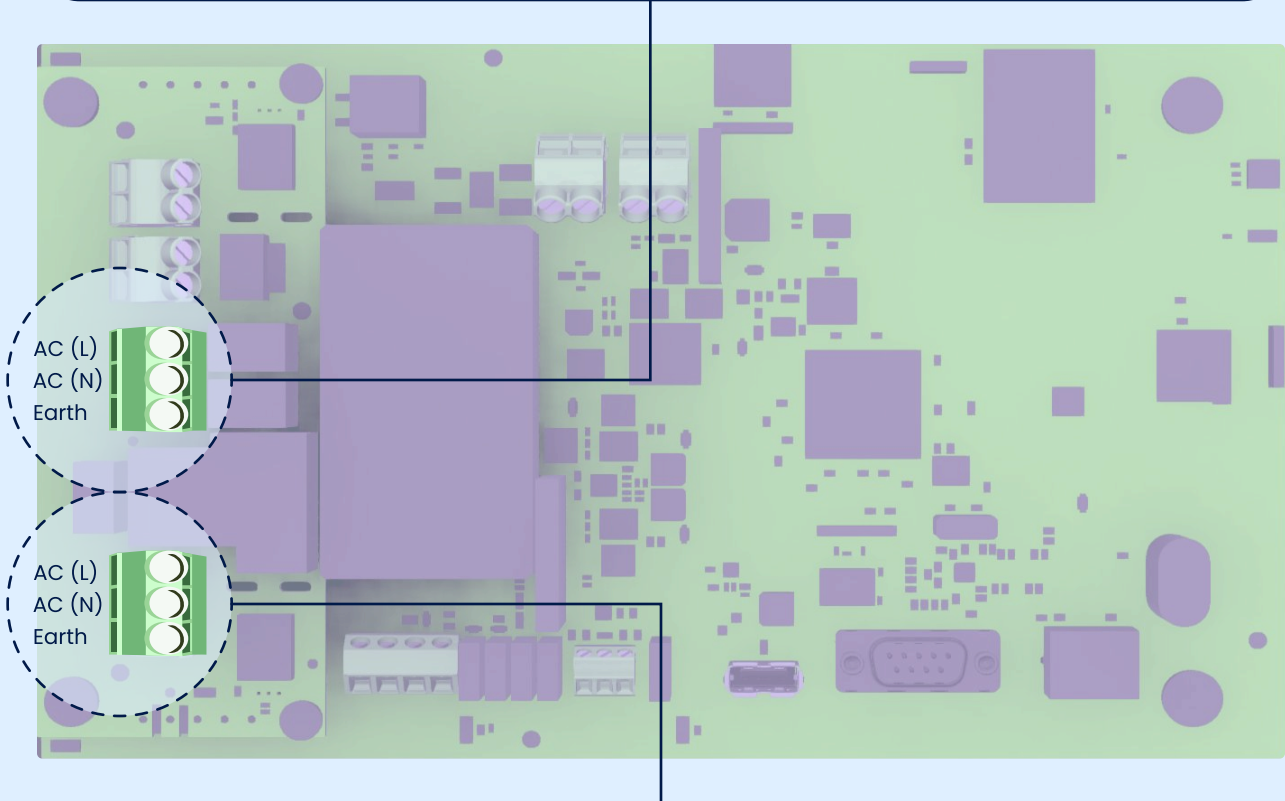

# 240VAC Pump Wiring

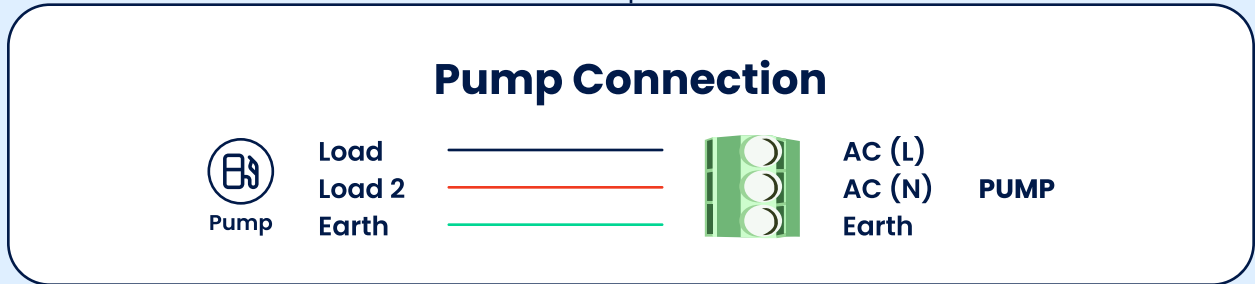
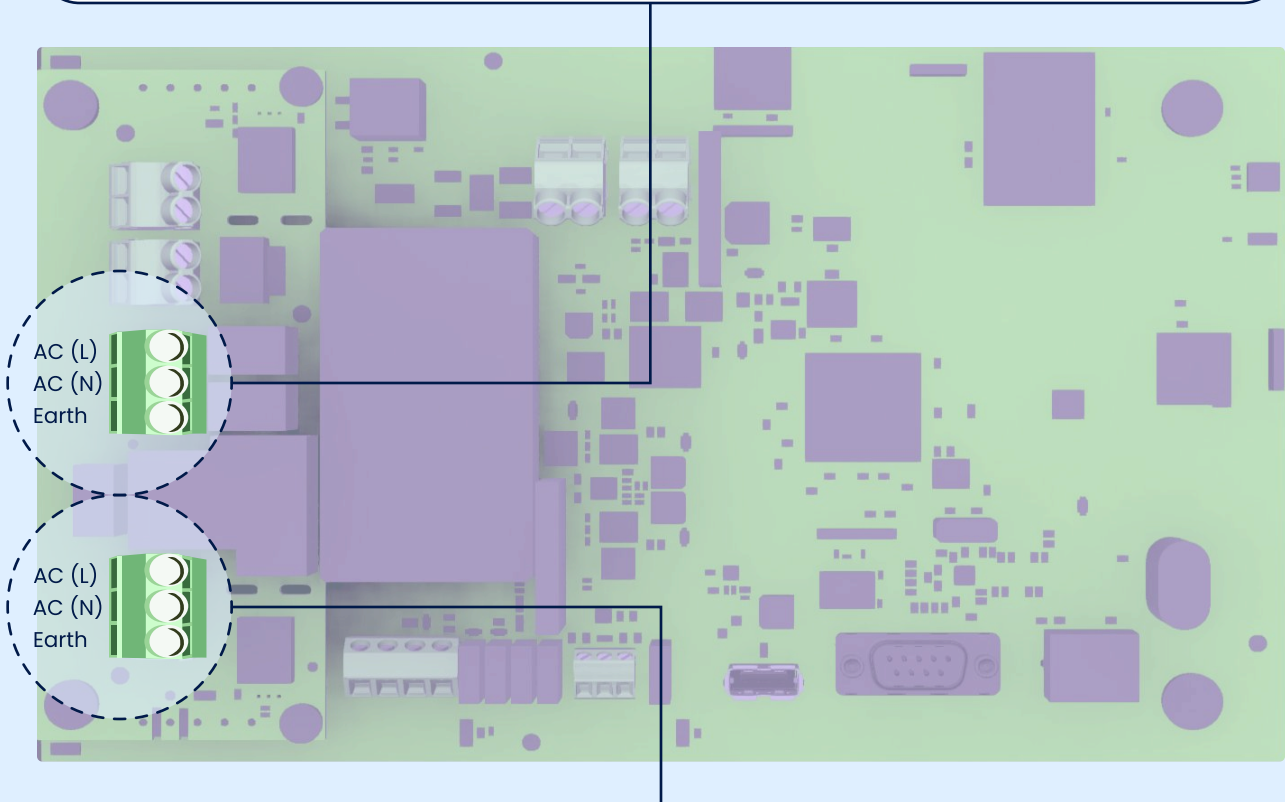
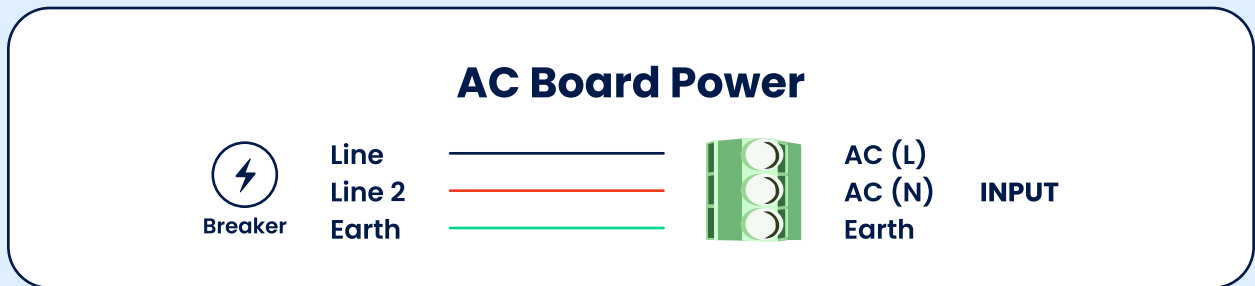



# DC Pump Wiring

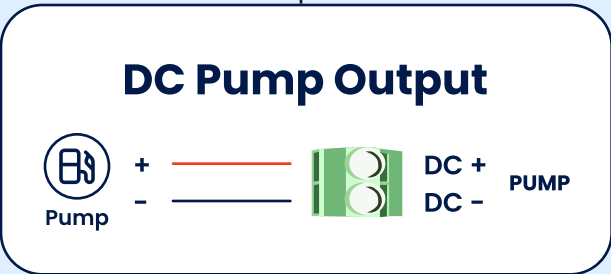
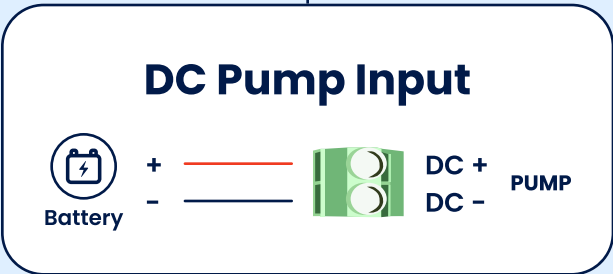
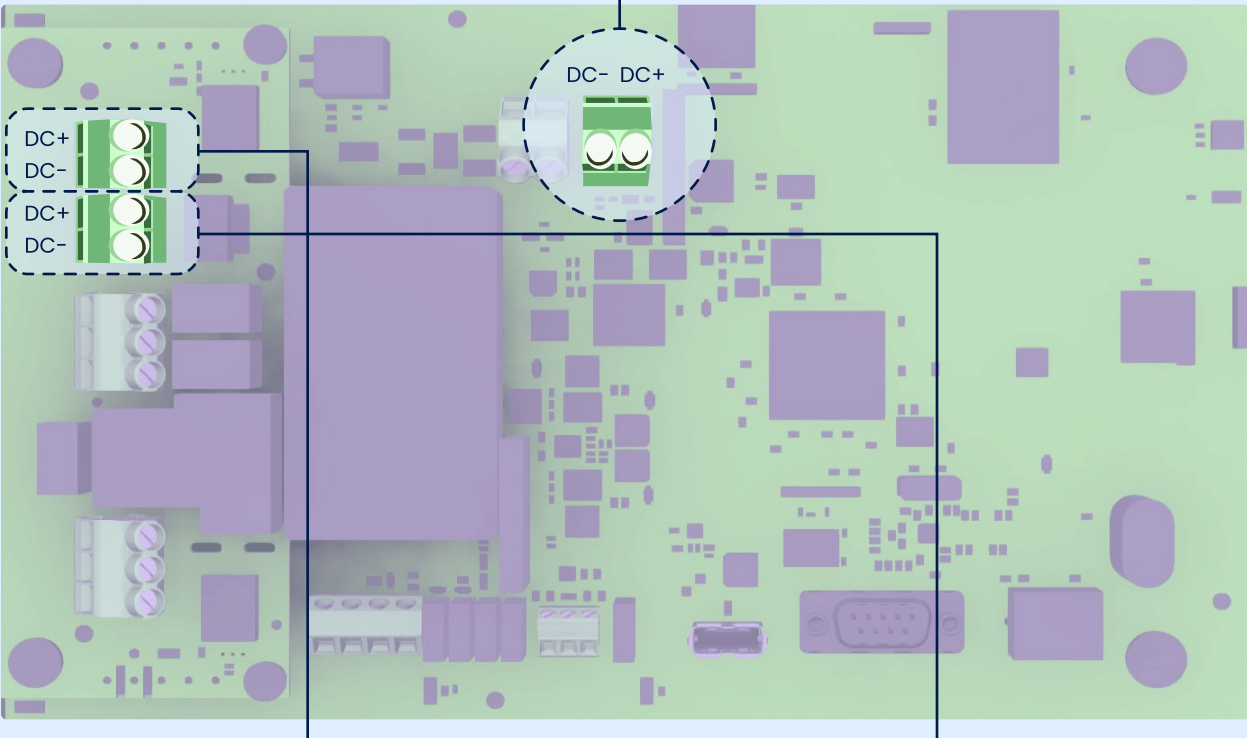
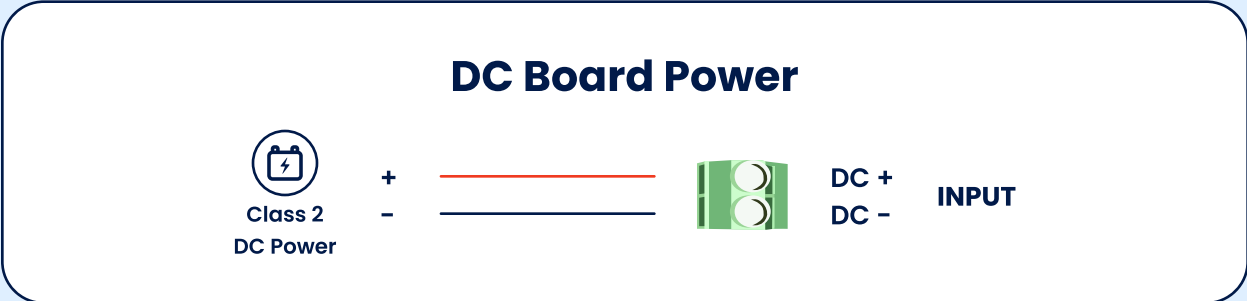

**Warning:** Pump DC- must be connected to the CloudBox. Connecting Pump DC- to the chassis or battery will cause the pump to stay on.

# Dispenser Control

## 120VAC Board Power



## Handle

Closes transactions when the hose is hung up.

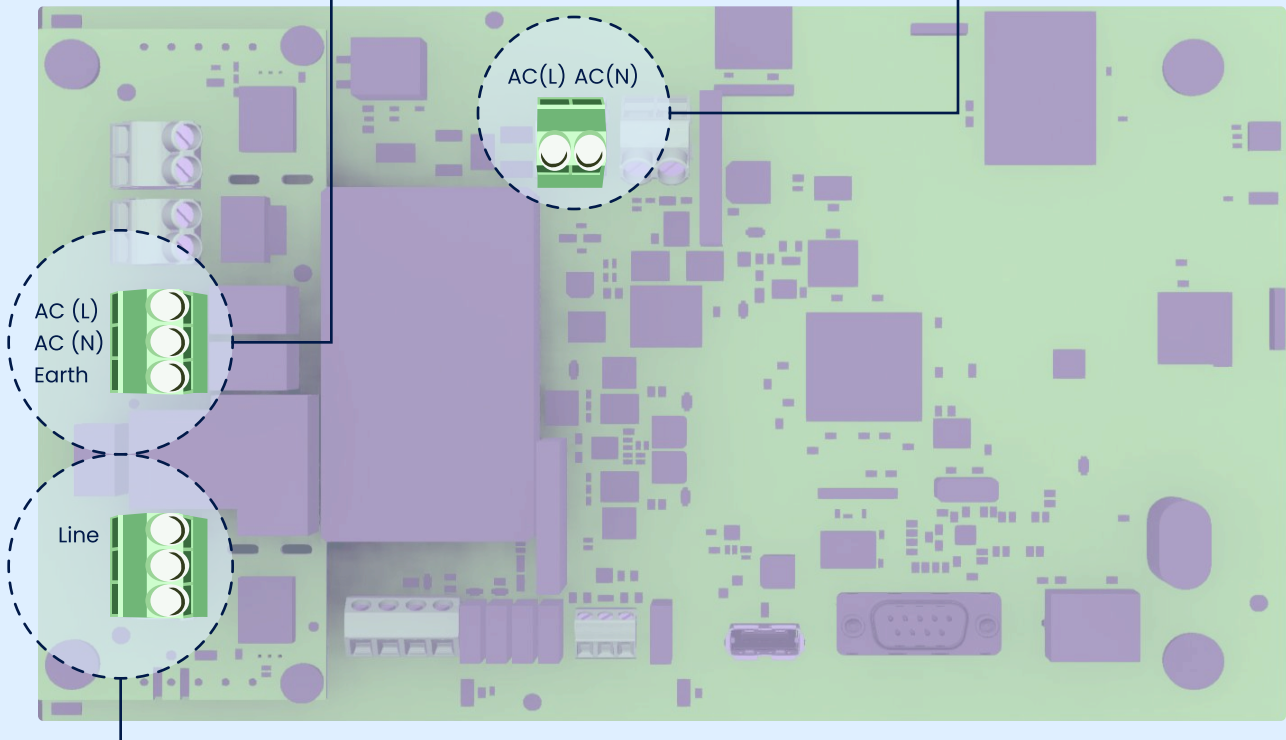

## Output

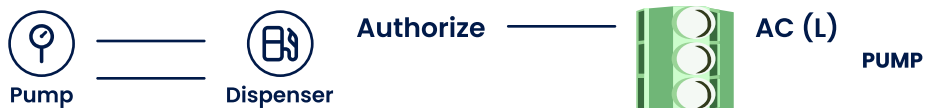

**Caution:** The CloudBox authorizes the dispenser. The pump should be controlled by the dispenser.

# INSTALLATION Pulsers

- All pulser wire should be shielded twisted pair wire (14-22AWG).
- Pulser wiring must not share the same conduit as pump AC power.
- Pulser shield must be connected to Earth on one end only.



**Warning:** Do not put Pulser Wire into AC Conduit. Doing so is a violation of fire code.

## 2-Wire Pulser:

- Attach one wire to the terminal marked "Pulse".
- Attach one wire to the terminal marked "GND".

## 3-Wire Pulser:

- Attach 12v power line from the pulser to the terminal marked "12V+".
- Attach signal wire to the terminal marked "Pulse".
- Attach the ground wire to the terminal marked "GND".

## Recommended wiring

### 2-Wire Pulsers

Passive

**Belden 8762**



### 3-Wire Pulsers

Active

**Belden 8772**



# Pulser Wiring

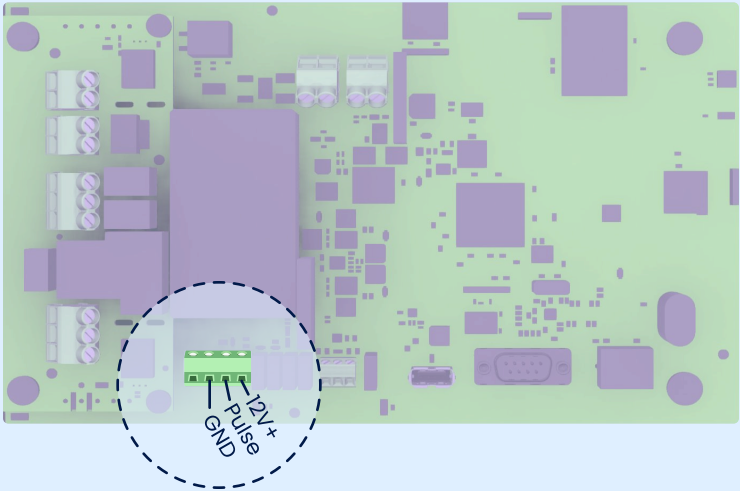

## 2-Wire (Passive) Pulser

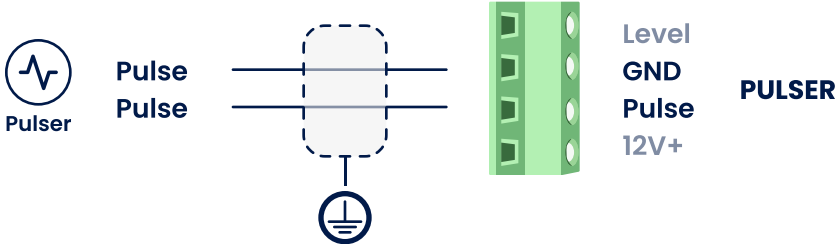

## 3-Wire (Active) Pulser

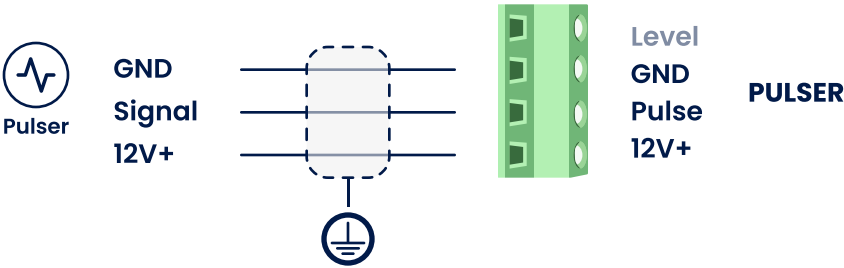

**Caution:** Connect the pulser wiring shield to earth to prevent electrical noise.



INSTALLATION

## Local Network Option



**Warning:** Do not connect the CloudBox to a PoE injector.

The CloudBox can be connected to a local network through the ethernet jack on the bottom right of the CloudBox board. When the CloudBox is connected to a local network, users can use their own Wi-Fi access point instead of the FuelCloud network.

- Broadcast forwarding must be enabled for the Wi-Fi network
- The network must have access to the internet
- If you wish to connect your CloudBox wirelessly, please contact FuelCloud support for instructions.

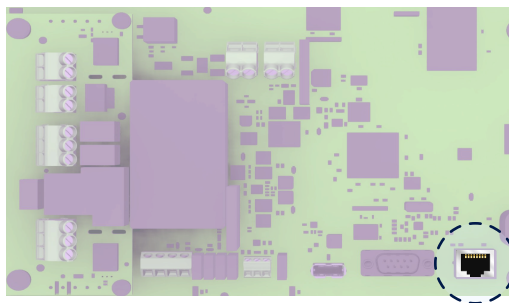

**Ethernet jack**



# Power On & Verification

After installing FuelCloud hardware and restoring power to the pump, verify the following items:

## 1 Power to the hardware

- Check that the lights and LEDs on the FuelCloud circuit board are illuminated.
- If the board does not have power, check that the circuit breaker has not tripped.

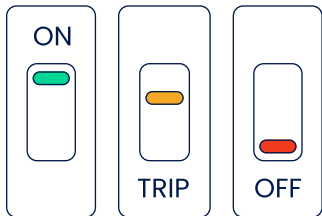

## 2 Bypass mode

- Switch the FuelCloud circuit board to Pump Bypass On.
- After testing, flip the bypass switch to Normal.

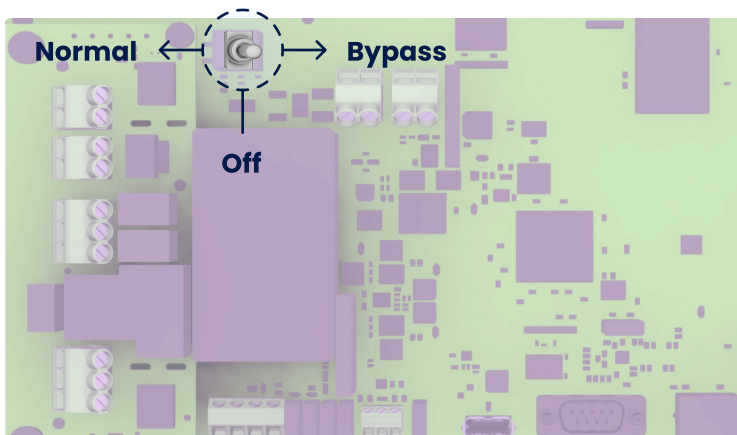

**Normal:** Pump is controlled by the app.

**Off:** No power will be allowed to the pump.

**Bypass:** Bypasses the FuelCloud app.

*Note: The FuelCloud app will still work in Bypass mode.*

### 3 Hardware Wi-Fi

- Ensure that your FuelCloud hardware is successfully broadcasting a Wi-Fi signal.
- On a Wi-Fi enabled device, you should be able to identify and join a Wi-Fi network titled "FuelCloud\_XXXXX". (XXXXX = the last five digits of the CloudBox's serial number)
- If using ethernet, connect to your local network.



**Warning:** An account needs to be created and registered at [fuelcloud.com](https://fuelcloud.com) before testing.

### 4 Test transaction

- Have the FuelCloud system administrator create a driver profile and pin code for you, and perform a test fueling using the FuelCloud mobile app.
- The FuelCloud app may perform a firmware update on first use. After the update has finished, try test fueling again.

### 5 Check pulse rate

- Confirm that the volume displayed on the FuelCloud app matches the volume of fluid being dispensed.
- There's a pulse LED on the CloudBox circuit board that turns on and off when the pulse signal is high or closed.



### 6 You are all finished. Congrats!

- For technical support, call FuelCloud Support: (844) 792-6071

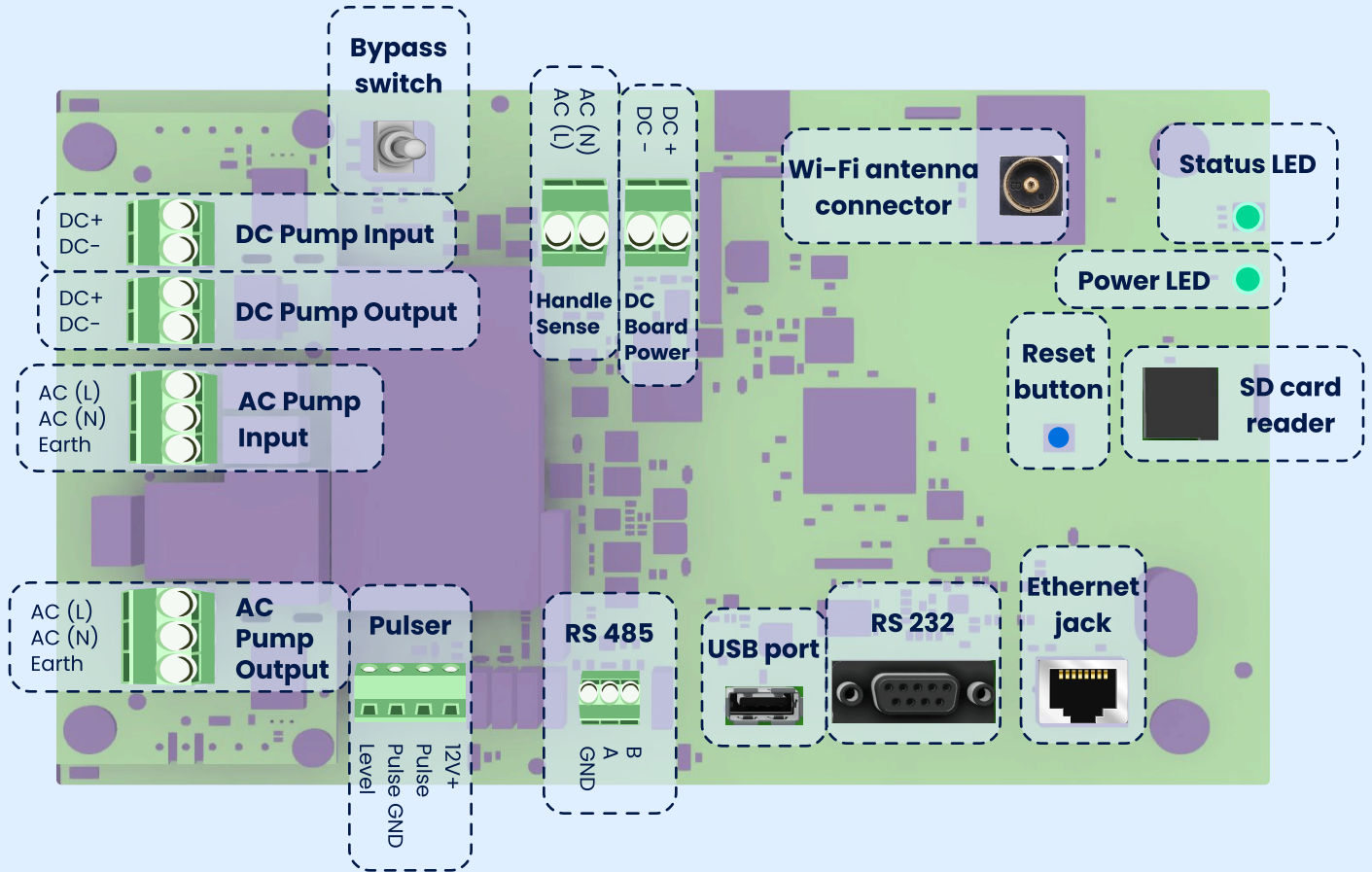
# CloudBox Overview



## Status LED colors:

-  **Green:** On and active
-  **Yellow:** On and inactive
-  **Purple:** No SD card











**Revised 1/13/25**

FuelCloud OPCO, LLC  
124 SW Dennis Ave  
Hillsboro, OR 97123